

POWER RESISTOR - PR02

FEATURES

- Metal film;
- High power in small package;
- Different leads for different applications;
- Several forming styles are available;
- Defined interruption behavior (fusing time);
- Non-flammable;
- High stability, reliability and uniformity characteristics;
- Several packing and taping configurations;
- Precision tolerance is available (1%);
- Good performance for pulse applications.

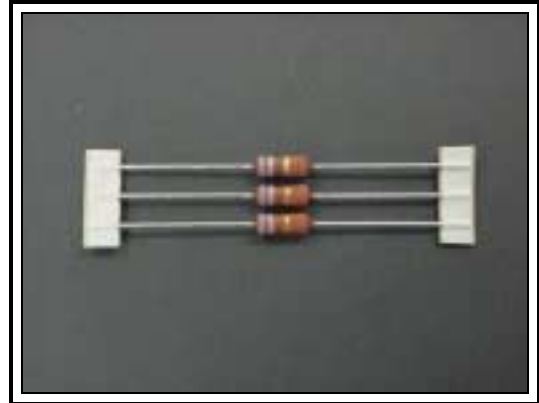

MARKET SEGMENTS AND APPLICATIONS

Industry sector	Application segment	End-user equipment
Industrial	Power	Power supplies Motor speed controls
Telecom	Data Communication	Line protection resistor Power supplies
Consumer	Sound & Vision	Amplifiers, Color monitor Television, Video cassette recorder
	Kitchen Appliances	Blender
	Lighting	Ballast equipment
Automotive	Electronic Systems	Dashboard electronics Lighting equipment Window/mirror steering ABS system, Alarm system Airbag, Electronic fuel injection

TECHNOLOGY

A homogenous film of metal alloy is deposited on a high grade ceramic body. After a helical groove has been cut in the resistive layer, tinned connecting wires of electrolytic copper or copper-clad iron are welded to the end-caps. The resistors are coated with a red, non-flammable lacquer, which provides electrical, mechanical and climatic protection. The encapsulation is resistant to all cleaning solvents in accordance with "MIL-STD-202E, method 215" and "IEC 60068-2-45".

PR02

QUICK REFERENCE DATA

DESCRIPTION	PR02 ±5% (E24 serie)		PR02 ±1% (E24/E96 series)	
	Cu-lead	FeCu-lead	Cu-lead	FeCu-lead
Resistance range	0.33 Ω to 1MΩ	1Ω to 1MΩ	1Ω to 1MΩ	
Maximum dissipation at Tamb 70°C	2W	1.3W	2W	1.3W
Thermal resistance (Rth)	75K/W	115K/W	75K/W	115K/W
Temperature coefficient	≤ ± 250 ppm/°C			
Limiting voltage (DC or RMS)	500V			
Rated Voltage ⁽¹⁾	$\sqrt{P_n \times R}$			
Basic specification	IEC 60115-1 and 60115-4			
Climatic category (IEC 60068)	55/155/56			
Stability, ΔR/Rmax., after:				
Load	±5% +0.1Ω		±1% +0.1Ω	
Climatic test	±3% +0.1Ω		±1% +0.1Ω	
Resistance to Soldering heat	±1% +0.05Ω		±0.5% +0.05Ω	

Note:

1- Maximum rated voltage is the "Limiting voltage".

MECHANICAL DATA

Axial style

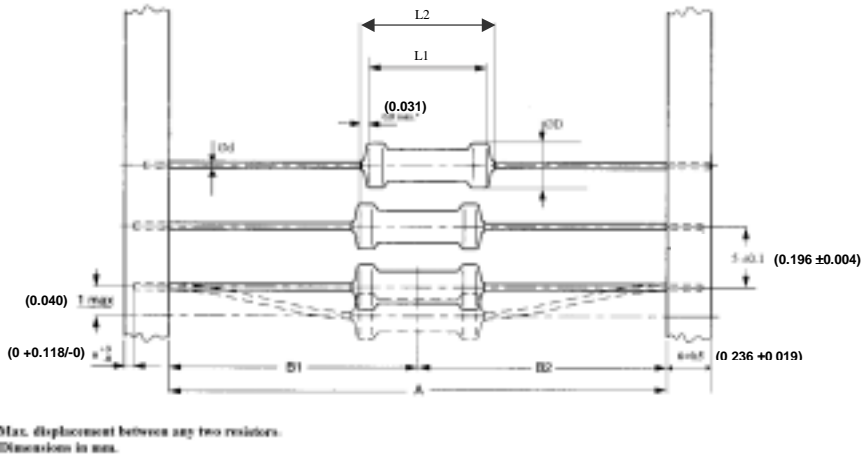

Table 1.

Type	A	L1 max	L2max	φDmax	B1-B2	φd	Mass per 100 units
PR02	52 +1.5/-0 (2.047 +0.059/-0)	10 (0.394)	12 (0.394)	3.9 (0.153)	± 1.2 (±0.047)	0.8 ± 0.03 Cu * (0.031 ±0.001 Cu*)	52
						0.6 ± 0.05 FeCu (0.024 ±0.002 FeCu)	46

*Preferred type
Dimensions in mm / (Inches)

MOUNTING

The resistors are suitable for processing on automatic insertion equipment, cutting and bending machines. A radial taped version economizes space on the PCB. The double kink style offers great advantages for manual insertion improving the mounting stability for the customer. They have a real *snap in* function to fix the resistor in PCB without weakening the connecting leads.

ELECTRICAL CHARACTERISTICS

DERATING

The power resistor that the resistor can dissipate depends on the operating temperature

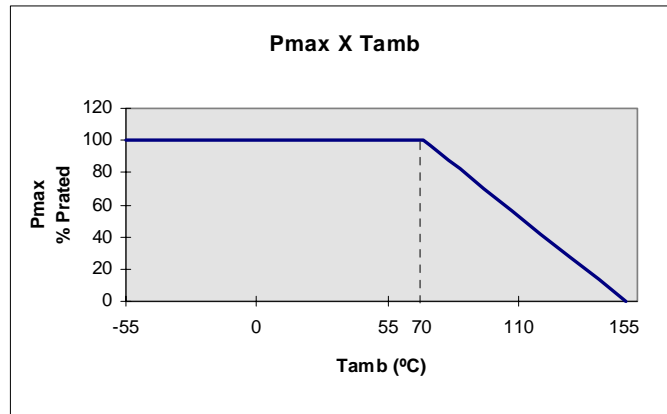

Maximum dissipation (Pmax.) in percentage of rated power as a function of ambient temperature (Tamb.).

APPLICATION INFORMATION

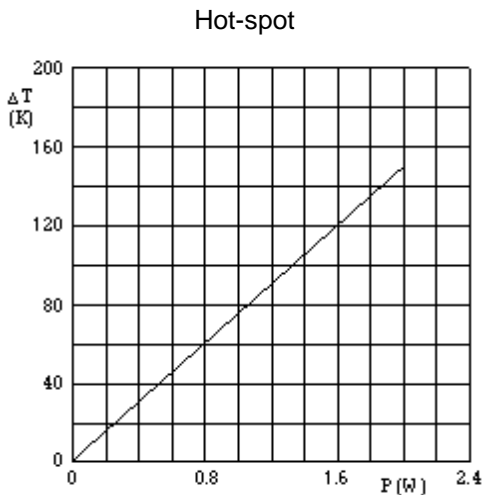

Fig. 1 - φ 0.8mm Cu – leads
Hot Spot temperature rise (ΔT)
as a function of dissipated power.

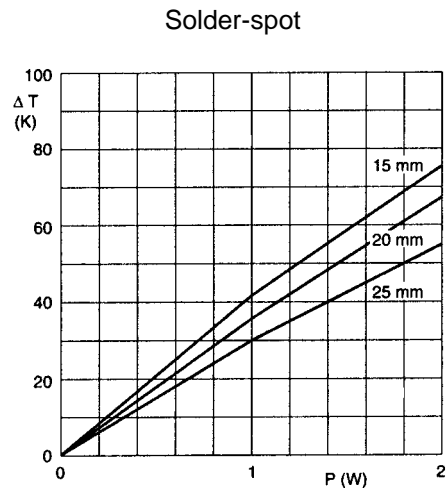

Fig. 2 - φ 0.8mm Cu – leads
Minimum distance from resistor body to PCB = 1mm
Temperature rise (ΔT) at the lead end
(Soldering point) as a function of dissipated power
at various leads lengths after mounting

Hot-spot

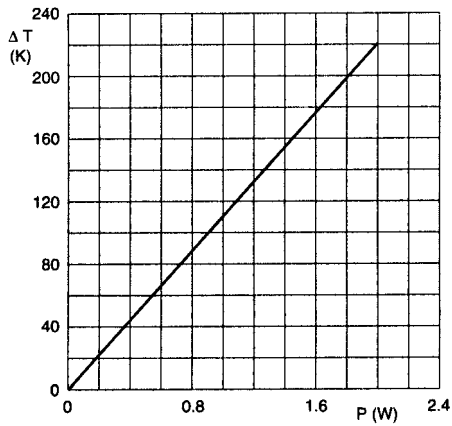

Fig. 3 - ϕ 0.6mm FeCu – leads
Hot Spot temperature rise (ΔT)
as a function of dissipated power.

Solder-spot

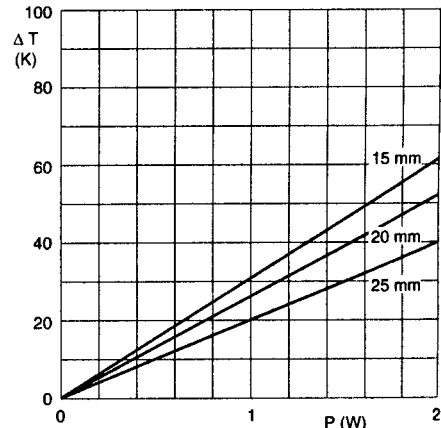

Fig. 4 - ϕ 0.6mm FeCu – leads
Minimum distance from resistor body to PCB = 1mm
Temperature rise (ΔT) at the lead end
(Soldering point) as a function of dissipated power
at various leads lengths after mounting.

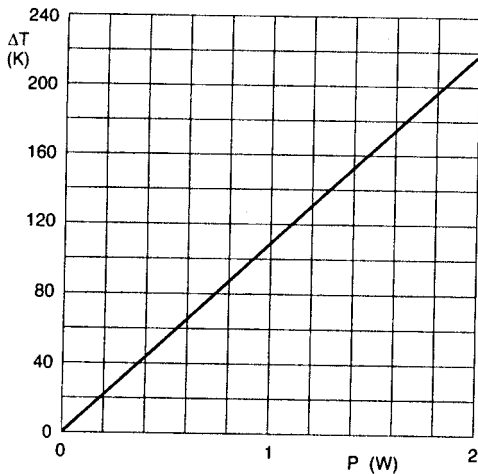

Fig. 5 - ϕ 0.8mm FeCu – leads
Hot Spot temperature rise (ΔT)
as a function of dissipated power.

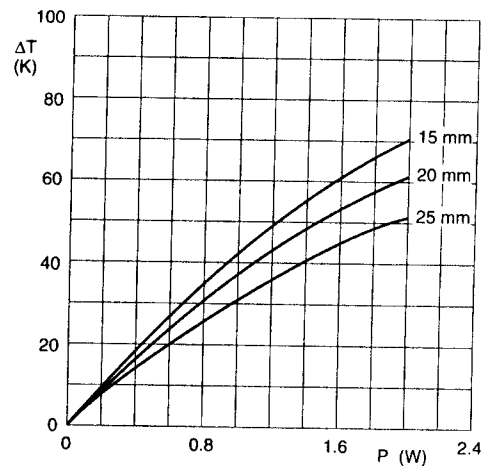

Fig. 6 - ϕ 0.8mm FeCu – leads
Minimum distance from resistor body to PCB = 1mm
Temperature rise (ΔT) at the lead end
(Soldering point) as a function of dissipated power
at various leads lengths after mounting.

Note:
The maximum permissible hot-spot temperature is 220°C.

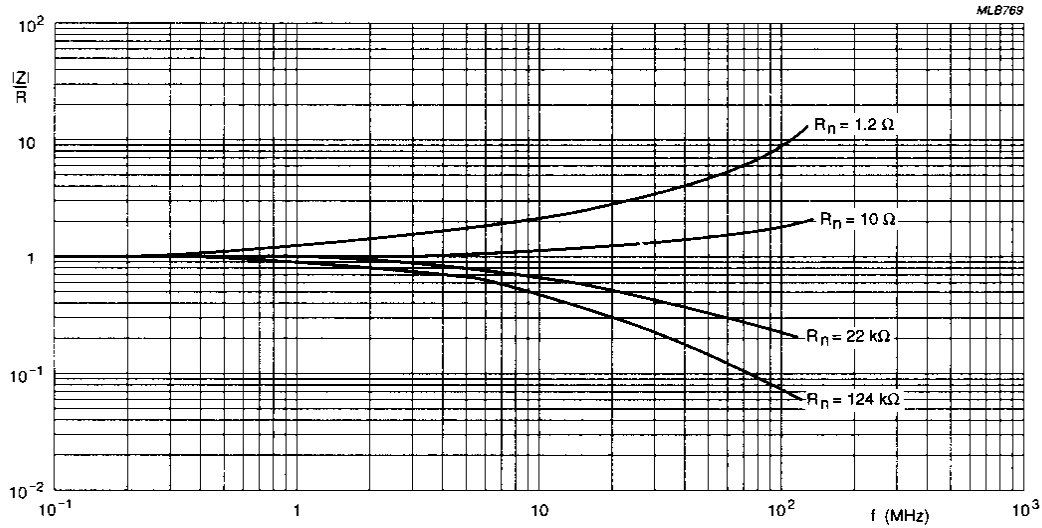

Fig. 7 - Impedance as a function of applied frequency.

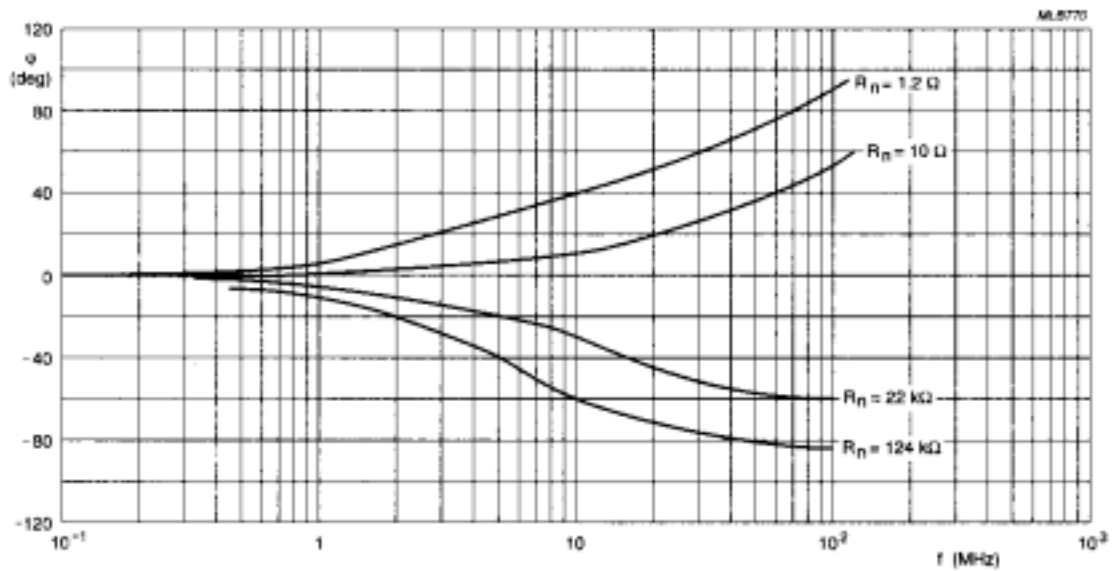

Fig. 8 - Phase angle as a function applied frequency.

PULSE LOADING CAPABILITIES

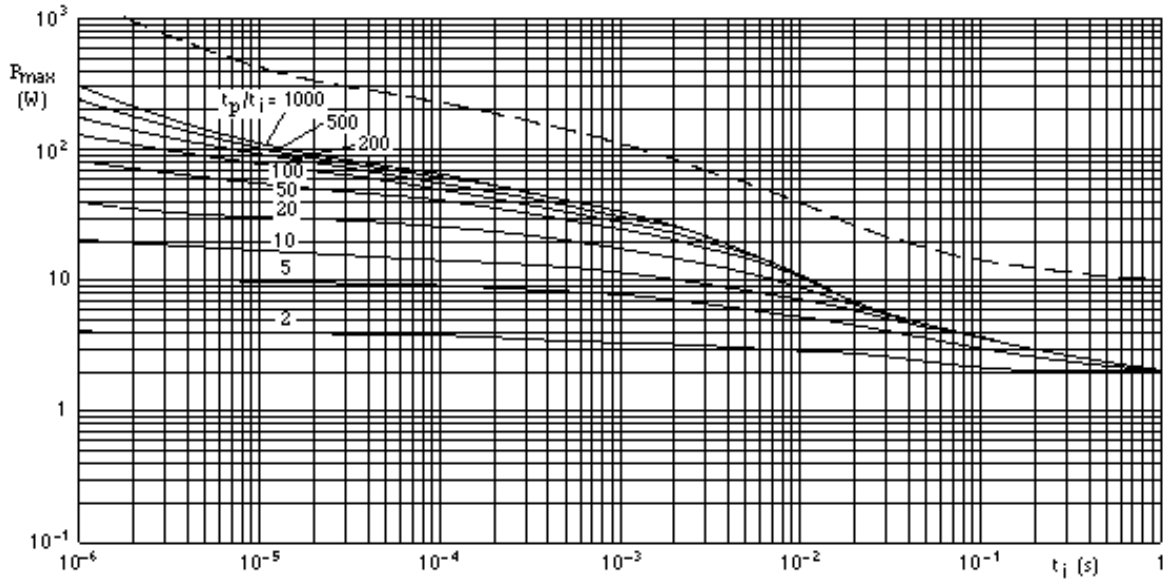

Fig. 9 – Pulse on a regular basis, maximum permissible peak pulse power (\hat{P}_{max}) as a function of pulse duration (t_i).

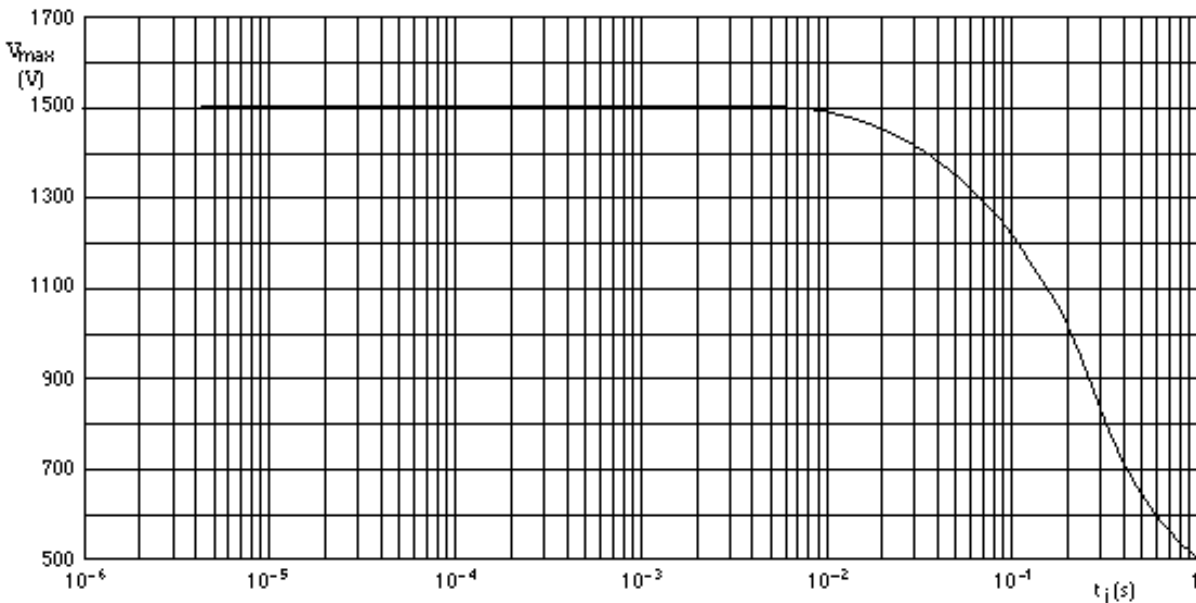

Fig. 10 - Pulse on a regular basis, maximum permissible peak pulse voltage (\hat{V}_{max}) as a function of pulse duration (t_i).

INTERRUPTION CHARACTERISTICS

The graph based on measured data under constant voltage conditions; these data may deviate according to the application.

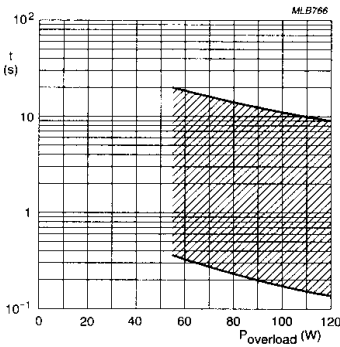

Fig. 11 - Time to interruption as a function of overload power for range: $0R33 \leq R_n < 5R$

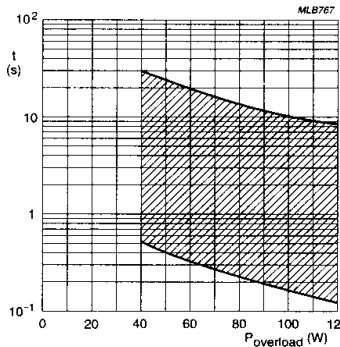

Fig. 12 - Time to interruption as a function of overload power for range: $5R \leq R_n < 68R$

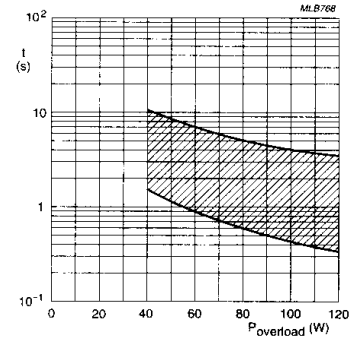

Fig. 13 - Time to interruption as a function of overload power for range: $68R \leq R_n < 560R$

MARKING

The nominal resistance and tolerance are marked on the resistor using four or five colored bands in accordance with IEC publication 60062 “color code for fixed resistors”. Standard values of nominal resistance are taken from the E24/E96 series for resistors with a tolerance of ±5% or 1%. The values of the E24/E96 series are in accordance with “IEC publication 60063”.

ORDERING INFORMATION

Table 2. Ordering code indicating resistor type and packaging

TYPE	LEAD Ø mm	TOL %	ORDERING CODE 23xx xxx xxxxx		
			BANDOLIER IN AMMOPACK		BANDOLIER ON REEL
			STRAIGHT LEADS		
			52 (2.047)	73 (2.847)	52 (2.047)
			1000 units	1000 units	5000 units
PR02	Cu 0.8 (Cu 0.031)	0.5	-	-	06 192 6xxxx
		1	22 197 1xxxx	-	06 192 5xxxx
	5	-	06 198 53xxx	22 194 13xxx	06 198 23xxx
		FeCu 0.6 (FeCu 0.024)	22 194 54xxx	-	-

Dimensions in mm / (Inches)

Note: For formed types see “Formed Types Specification”

PR02

ORDERING CODE

- The resistors have a 12 digit ordering code starting with 23
- The subsequent 6 or 7 digits indicate the resistor type and packaging see table 2.
- For 5% tolerance the remaining 3 digits indicate the resistance value;
 - The first 2 digits indicate the resistance value.
 - The last digit indicates the resistance decade in accordance with table 3.
- For 1% tolerance the remaining 4 digits indicate the resistance value;
 - The first 3 digits indicate the resistance value.
 - The last digit indicates the resistance decade in accordance with table 3.

Table 3. Last digit of 12NC

RESISTANCE DECADE (5%)	RESISTANCE DECADE (1%)	LAST DIGIT
0.33 to 0.91 Ω	-	7
1 to 9.1 Ω	1 to 9.76 Ω	8
10 to 91 Ω	10 to 97.6 Ω	9
100 to 910 Ω	100 to 976 Ω	1
1 to 9.1k Ω	1 to 9.76k Ω	2
10 to 91k Ω	10 to 97.6k Ω	3
100 to 910k Ω	100 to 976k Ω	4
1M Ω	1M Ω	5

Example:

The ordering code for resistor type PR02 with Cu leads and a value of 750 Ω 5%, supplied on a bandolier of 1000 units in ammopack, is: 2306 198 53751

NAFTA ORDERING INFORMATION – CROSS REFERENCE

NAFTA ORDERING CODES

Table 4. Ordering code indicating resistor type and packaging

Type	Tol. %	Resistance range	12NC	NAFTA Part Number	Taping	SPQ units
PR02	± 5	0.33 Ω to 1M Ω	2306 198 53xxx	5083NWxxxxxJA8AFX	52 (2.047)	1000; ammopack
			2306 198 23xxx	5083NWxxxxxJ12AFX	52 (2.047)	5000; reel
			2322 194 54xxx	5083NWxxxxxJA8AFXF06	52 (2.047)	1000; ammopack
	± 1	1 Ω to 1M Ω	2306 197 1xxxx	5083NWxxxxxFA8AF5	52 (2.047)	1000; ammopack
			2306 192 5xxxx	5083NWxxxxxJ12AF5	52 (1.047)	5000; reel

Dimensions in mm / (Inches)

PR02

COMPOSITION OF OHMIC VALUE

The ohmic value is represented by 5 digits; see table 5.

Table 5. Examples of the ohmic value

Value	5 Digits (All Other)
1 Ω	1R000
10 Ω	10R00
100 Ω	100R0
1 K Ω	1K000
10 K Ω	10K00
100 K Ω	100K0
1 M Ω	1M000

PACKAGING

Bandolier in ammopack

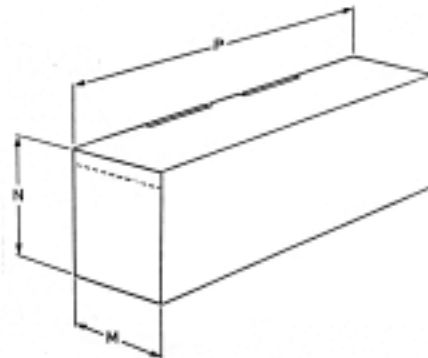

Table 6.

Product	Quantity	M	N	P	Bandolier Width
PR02	1000	78 (3.071)	60 (2.362)	262 (1.0315)	52 +1.5/-0 (2.047 +0.059/-0)
		92 (3.622)	60 (2.362)	262 (1.0315)	73 \pm 1.5 (2.847 \pm 0.059)

Dimensions in mm / (Inches)

PR02

Bandolier on Reel (optional)

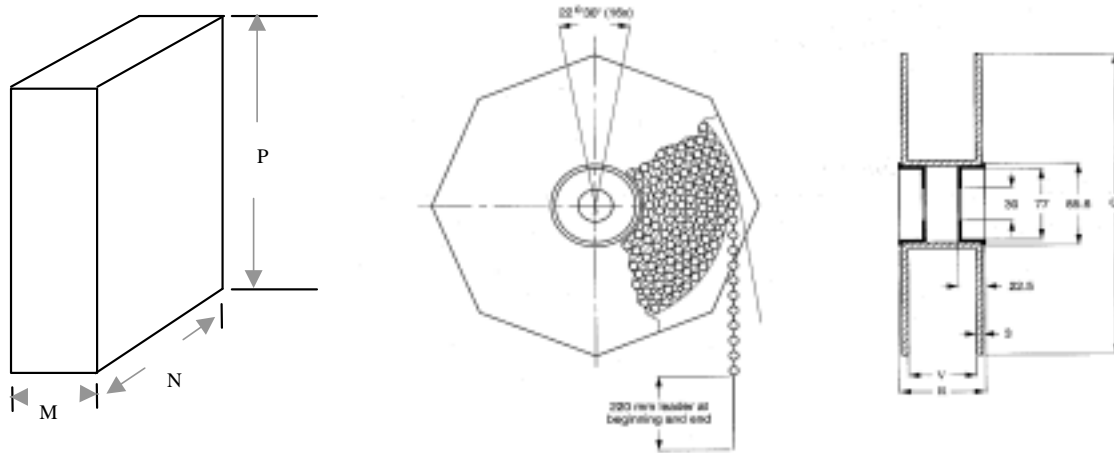

Table 7.

Product	Quantity	M	N	P	Q	V	R	Bandolier Width
PR02	5000	95 (3.740)	361 (14.212)	361 (14.212)	355 (13.976)	78 (3.071)	89 (3.504)	52 +1.5/-0 (2.047 +0.059/-0)

Dimensions in mm / (Inches)

TESTS AND REQUIREMENTS

Essentially all tests are carried out in accordance with the schedule of “IEC publication 60115-1”, category LCT/UCT/56 (rated temperature range: Lower category temperature, upper category temperature; damp heat, long term, 56 days). The testing also covers the requirements specified by EIA and EIAJ.

The tests are carried out in accordance with IEC publication 60068-2, “Recommended basic climatic and mechanical robustness testing procedure for electronic components” and under standard atmospheric conditions according to “EC 60068-1”, subclause 5.3.

In Table 8 the tests and requirements are listed with reference to the relevant clauses of “IEC publications 60115-1 and 60068-2”; a short description of the test procedure is also given. In some instances deviations from the IEC recommendations were necessary for out method of specifying. All soldering tests are performed with mildly activated flux.

Table 8. Test procedures and requirements

IEC 60115-1 CLAUSE	IEC 60068-2 TEST METHOD	TEST	PROCEDURE	REQUIREMENTS	
				PR02 5%	PR02 1%
4.4.1		Visual examination		No holes; clean surface no damage	

PR02

IEC 60115-1 CLAUSE	IEC 60068-2 TEST METHOD	TEST	PROCEDURE	REQUIREMENTS	
				PR02 5%	PR02 1%
4.4.2		Dimensions (outline)	Gauge (mm)	See table 1	
4.5		Resistance	Applied voltage (+0/-10%): R<10Ω: 0.1V 10Ω ≤ R < 100Ω: 0.3V 100Ω ≤ R < 1 kΩ : 1V 1kΩ ≤ R < 10 kΩ:3V 10 kΩ ≤ R < 100 kΩ: 10V 100 kΩ ≤ R < 1MΩ: 25V R = 1MΩ: 50V	R - Rnom: max.: ± 5%	R - Rnom: max.: ± 1%
4.6.1.1		Insulation resistance	Maximum voltage (DC) after 1 minute; metal block method.	R _{ins} min.: 10 ⁴ MΩ	
4.7		Voltage proof on insulation	Maximum voltage 500V (RMS) during 1 minute; metal block method.	No breakdown or flashover	
4.8.4.2		Temperature coefficient	At 20/ LCT /20°C and 20/ UCT / 20°C: (TC ppm/°C)	≤ ± 250ppm	
4.16	21 (U)	Robustness of Terminations:			
4.16.2	21 (Ua1)	Tensile all samples	Load 10N; 10s	Number of failures:<1x10 ⁻⁶	
4.16.3	21 (Ub)	Bending half number of samples	Load 5N; 4 X 90°	Number of failures:<1x10 ⁻⁶	
4.16.4	21 (Uc)	Torsion other half number of samples	3 x 360° in opposite directions	No damage ΔR/Rmax.:±0.5% + 0.05Ω	
4.17	20 (Ta)	Solderability	2s; 235°C;	Good tinning; no damage	
		Solderability (after ageing)	8 hours steam or 16 hours 155°C; leads immersed 6mm for 2 ±0.5 s in a solder bath at 235 ± 5°C.	Good tinning (≥95% covered); no damage	
4.18	20 (Tb)	Resistance to soldering heat	Thermal shock: 3s; 350°C ; 6mm from body	ΔR/Rmax.: ±1% + 0.05Ω	ΔR/Rmax.: ±0.5% +0.05Ω
4.19	14 (Na)	Rapid change of temperature	30 minutes at LCT and 30 minutes at UCT; 5 cycles	No visual damage	
				ΔR/Rmax.: ±1%+0.05Ω	ΔR/Rmax.: ±0.5% +0.05Ω
4.22	6 (Fc)	Vibration	Frequency 10 to 500 Hz, displacement 1.5mm or acceleration 10g, three directions; total 6h (3x2h)	No damage ΔR/Rmax.: ±0.5% +0.05Ω	
4.23		Climatic sequence		R _{ins} min.: 10 ³ MΩ	
4.23.3	30 (Db)	Damp heat (accelerated) 1 st cycle			
4.23.6	30 (Db)	Damp heat (accelerated) remaining cycles	6 days; 55°C; 95 to 98% R.H.	ΔR/Rmax.: ± 3% + 0.1Ω	ΔR/Rmax.: ± 1% + 0.1Ω

PR02

IEC 60115-1 CLAUSE	IEC 60068-2 TEST METHOD	TEST	PROCEDURE	REQUIREMENTS	
				PR02 5%	PR02 1%
4.24.2	3 (Ca)	Damp heat (steady state) (IEC)	56 days; 40 °C; 90 to 95% R.H; loaded with 0.01Pn (IEC steps: 4 to 100V)	R _{ins} min.: 10 ³ MΩ	
				ΔR/R max.: ± 3% + 0.1Ω	ΔR/R max.: ± 1% + 0.1Ω
4.25.1		Endurance (at 70 °C)	1000h loaded with Pn or Vmax 1.5h on and 0.5h off	ΔR/Rmax.: ± 5% + 0.1Ω	ΔR/Rmax.: ± 1% + 0.1Ω
4.29	45 (Xa)	Component solvent resistance	Isopropyl alcohol or H ₂ O followed by brushing in accordance with "MIL 202F"	No visual damage	
See 2 nd amendment to "IEC 60115-1".		Pulse Load		See figs. 9 and 10	